

[VISION]

LED FLOODLIGHT

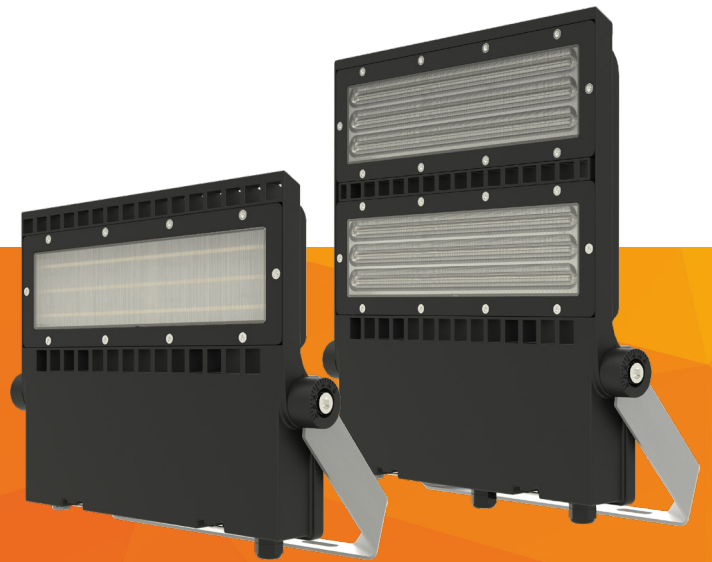

5
YEAR
PRODUCT
WARRANTY

IP
66
INGRESS
PROTECTION

IK
10
IMPACT
PROTECTION

Description

The [VISION] is a corrosion resistant floodlight designed for the harshest marine and industrial applications. A combination of powder-coated aluminium and 316 grade stainless steel materials ensure this floodlight will stand up to any environment. In addition to the corrosion resistance, the [VISION] has a high impact protection rating and efficacy to ensure it will perform well in all applications.

Key Features

- High luminous efficacy of 140lm/w
- Premium components with 5-year warranty
- Unique open heatsink to prevent dirt build up
- 316 marine grade stainless steel fixings, specially treated to maximise corrosion resistance

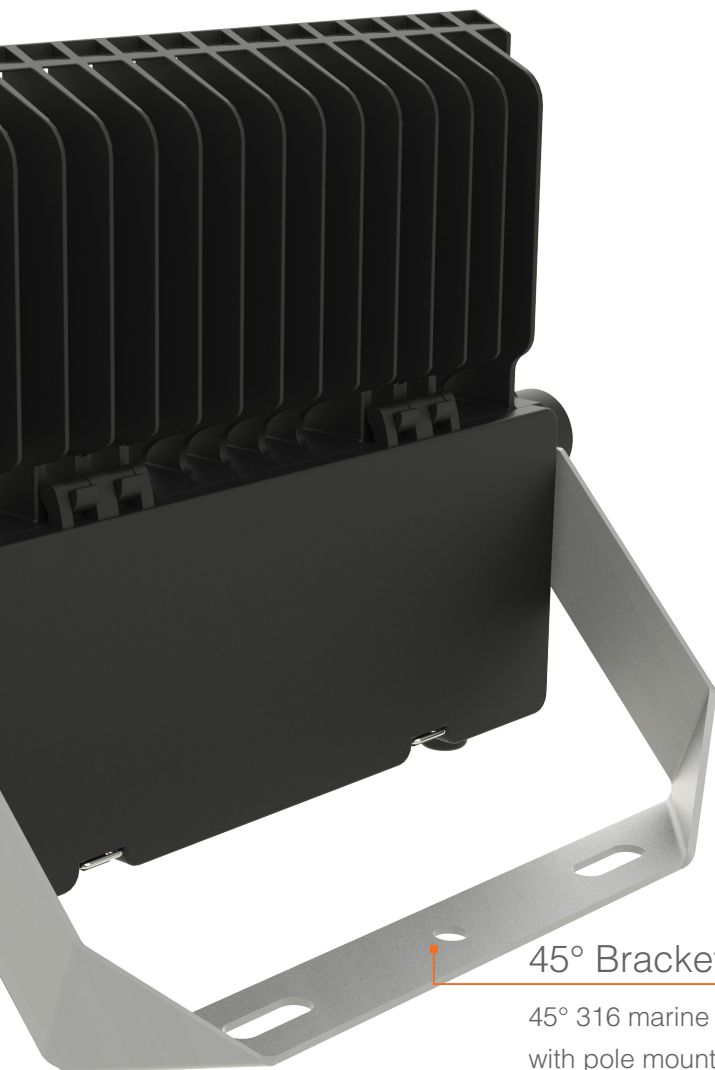

45° Bracket

45° 316 marine grade stainless steel bracket with pole mount option also available.



Pole Mount Option

Multiple installation options available.



Technical Specifications

Rated Life	≥50,000 hours
Body	Aluminium, 316 Marine Grade Stainless Steel
Installation	Bracket
Beam Angle	T2
Power Factor	>0.95

CRI	>70
Operating Temperature	-40°C to +50°C
Input Voltage	90 - 305 VAC ~ 50/60Hz
IP Rating	IP66
Connection	Terminal Block

Dimensional Drawing

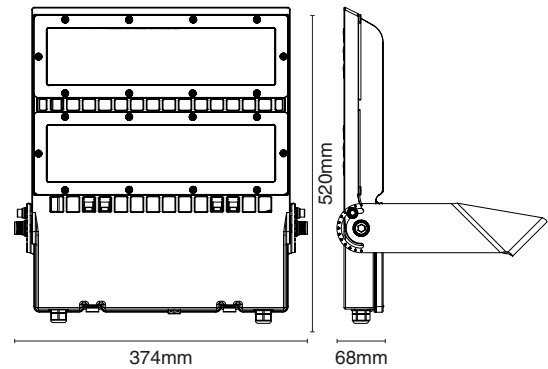
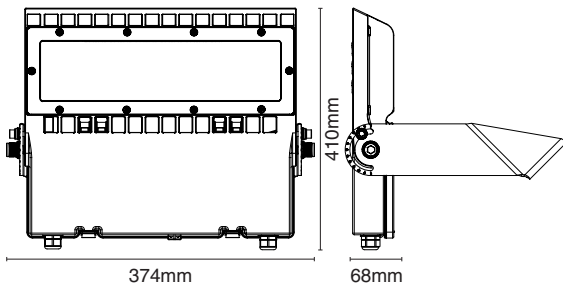

Model	Length	Width	Depth	Weight
FV-75DT2	410mm	374mm	68mm	5.3kg
FV-150DT2	410mm	374mm	68mm	5.5kg

Model	Length	Width	Depth	Weight
FV-240DT2	520mm	374mm	68mm	7.1kg

Photometry

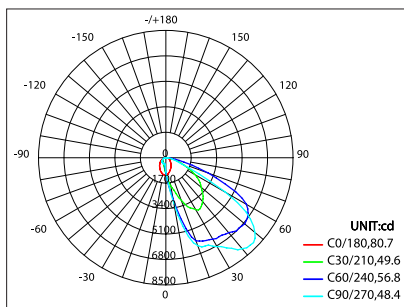

75W

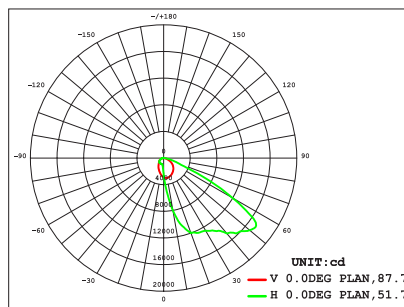

150W

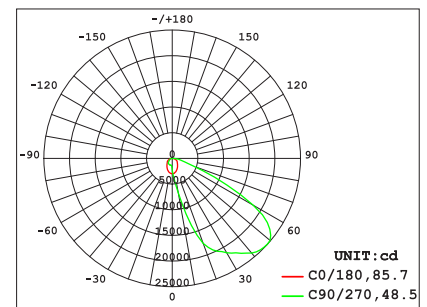

240W

Product Data

Part Number	Power	Lumen Output	CCT
FV-75DT2	75W	10,500lm	5000K
FV-150DT2	150W	21,000lm	5000K
FV-240DT2	240W	33,600lm	5000K

Other colours, wattages and distributions available as special order, please contact your Teknik Lighting Solutions representative for further information.

Accessories



Pole Mount
FV-BRKT-PM